

### Lab Questions?

- The minimal # of gates may not be sum-of-product form. What else is there?

$$(A \text{ nor } B) = \overline{(A+B)}$$

CS Welcome Session - today at 5pm

find link in email or on CS team

1 0 1 1 0 0 1  
64 32 16 8 4 2 1

$$64 + 16 + 8 + 1 = \underline{89}$$

### Adders

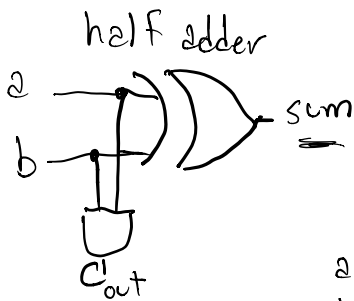

a	b	sum	Cout
0	0	0	0
0	1	1	0
1	0	1	0
1	1	0	1

$$\begin{array}{r} 1010 \\ + 0011 \\ \hline 101 \end{array}$$

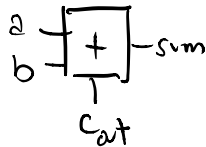

### Full adder

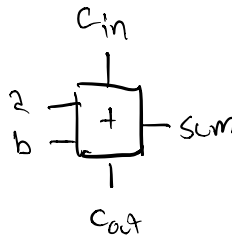
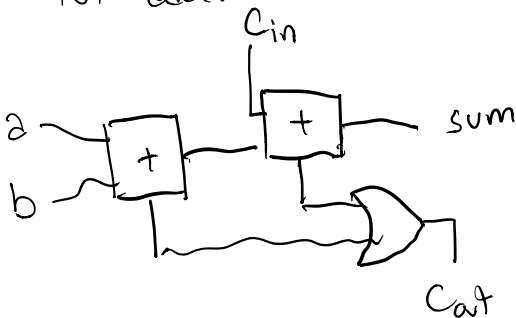

Adding four-bit numbers

$$A = 1010 \quad B = 0111$$



$$C = A + B$$

$$\begin{array}{r} 1010 \\ + 0111 \\ \hline 10001 \end{array}$$

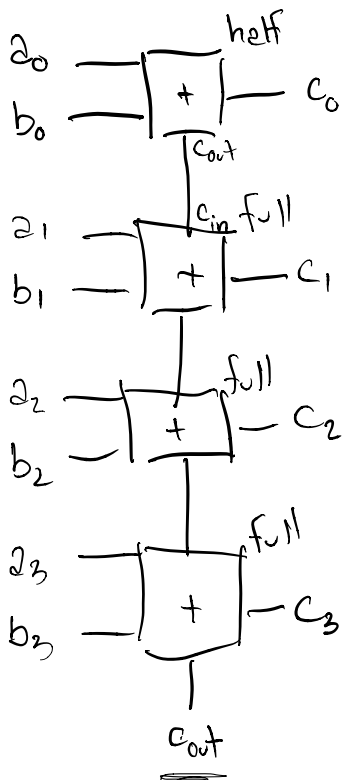

# ALU

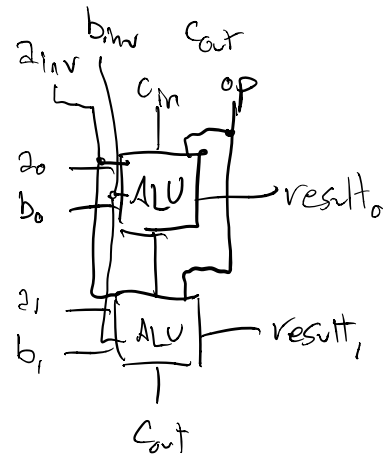
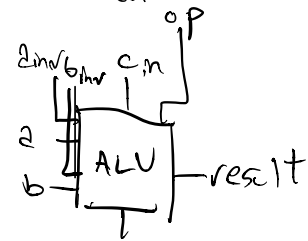
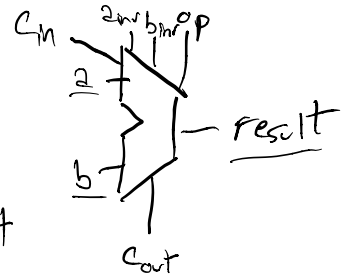
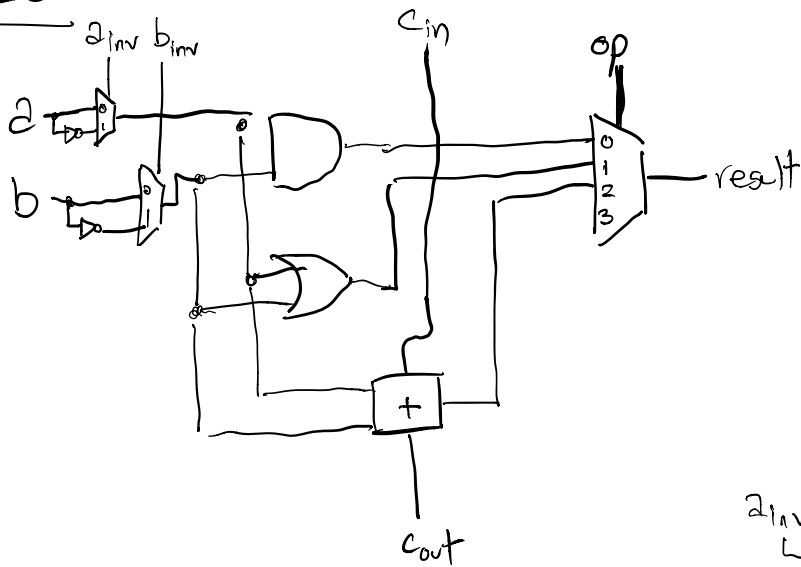

NOR =  $\overline{a \vee b}$  =

NAND =  $\overline{a \wedge b}$  =

operation	a <sub>inv</sub>	b <sub>inv</sub>	c <sub>in</sub>	op	
a and b	0	0	X	00	a & b, not a & & b
a or b	0	0	X	01	
a + b	0	0	<u>0</u>	10	$\begin{array}{r} 1011 \\ \&0110 \\ \hline 0010 \end{array}$
a nand b	1	1	X	01	
a nor b	1	1	X	00	
a - b	0	1	1	10	

## Two's Complement Numbers

$$\begin{array}{r} 1001 \\ 8421 \\ -8421 \end{array}$$

in unsigned  
 $8 + 1 = 9$

in signed  
 $-8 + 1 = -7$

$$\begin{array}{r} 1001 \\ +0110 \\ \hline 1111 \\ -8421 \end{array}$$

$$\begin{array}{r} 9 \\ +6 \\ \hline 15 \end{array}$$

$$\begin{array}{r} -7 \\ +6 \\ \hline -1 \end{array}$$

$$-8 + 4 + 2 + 1 = -8 + 7 = -1$$